

***RIGblaster standard
models M8, M4, RJ***

rig to sound card interfaces

OWNERS MANUAL

4TH EDITION

West Mountain Radio

<http://www.westmountainradio.com>

**IF YOU CAN'T FIND IT HERE GO TO OUR SUPPORT PAGE:
<http://www.westmountainradio.com/support.htm>**

18 Sheehan Avenue, Norwalk, CT 06854 tel 203 853 8080 fax 203 299 0232

**Typical Yaesu Modular RJ45 jumper connections
FT817, FT900 AND MOST FM MOBILE RIGS**

Pin #	Connection
1	Direct connection
2	PTT common (Ground)
3	Push to talk, PTT
4	Microphone audio
4	MIC Ground/Common
6	Direct blue shunt jumper
7	Direct blue shunt jumper
8	Direct blue shunt jumper

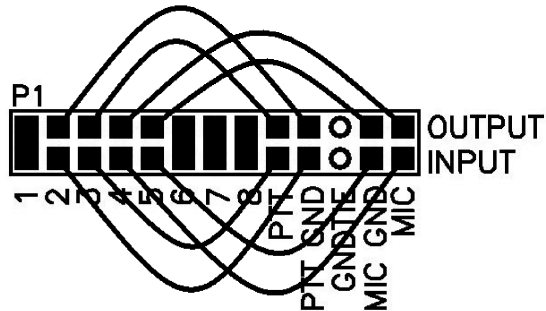

M4 VERSION ONLY or M4 adaptor kit with M8

Typical Ten Tec jumper connections

Pin #	Connection
1	Microphone audio
2	PTT and Mic. com/gnd
3	Push to talk, PTT
4	Direct connection
5	not used
6	not used
7	not used
8	not used

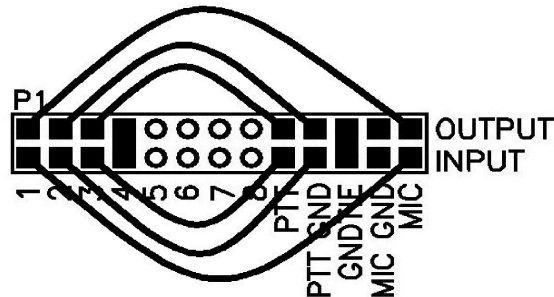

Note: There is a 2 pin jumper on the GNDTIE pin as Ten Tec uses a common mic. and PTT ground.

Typical 4 PIN Kenwood (TS530/830) jumper connections

Pin #	Connection
1	Microphone audio
2	Push to talk, PTT
3	PTT Ground/Common
4	MIC Ground/Common
5	not used
6	not used
7	not used
8	not used

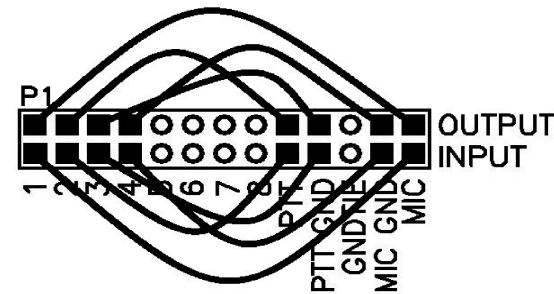

RIGblaster rig to sound card interface

Thank you for buying the RIGblaster. We are sure you will find it provides many hours of amateur radio enjoyment. Please read and follow these instructions carefully for a fast and easy installation.

INSTALLATION INSTRUCTIONS (PROCEED IN ORDER, STEP BY STEP!)

1. INSTALL SOFTWARE AND START RECEIVING: You do not need the RIGblaster to receive so leave it in the box. Use our CD or check for newer versions of the software on the internet. If you do not have a preference for which program or mode you would like to try first, we recommend that you start with WinPSK or DIGIpan.

Hook up a receive audio cable according to the diagram in this manual. We recommend that the speaker output from your radio goes to the line input on your computer for the receive audio connection. Other connections may be used but they may require proper grounding. One grounding precaution is make sure that your computer is plugged in to the same grounded outlet as your radio. Do not try to run your computer on one circuit in your house and your radio on another; you are asking for problems.

Read your software documentation carefully and you should be up and receiving in minutes. Most start-up problems are software related!

After you get your software receiving, next check the transmit audio. You should be able to hear transmit sound from the software. This is an important test of your sound card's proper operation.... no transmit sound...no transmit! Do not proceed further until you fix this.

If you have any problem with the software you try initially, simply try another program. If several programs do not work, you probably have a sound card set up problem. Sound card problems are supported by the hardware manufacturer. Please do not contact us if you have a sound card problem, we probably cannot help.

Continue to the next step only after you have confirmed that you can receive and have transmit sound. See the software documentation if you have problems.

2. CHECK AND SET THE RIGblaster JUMPERS: Jumpers are not installed for operation as shipped out of the box; they are packed separately. Install the jumpers. See the section later in this manual for jumper installation details.

Next, hook up the RIGblaster mic. cable, connect the power supply, and plug in your stock mic (the one that came with the radio). Confirm that EVERYTHING on the original mic. works perfectly, including on-the-air audio reports. If the stock mic. works perfectly, this confirms that the jumpers are installed correctly. If you were using another mic. install it and check it also.

If your mic. works perfectly, you may continue to the next step.

3. CONNECT A SERIAL CABLE: (SKIP THIS STEP FOR VOX OPERATION) Use a standard modem cable connected between an available serial port on your computer and the RIGblaster (do not use a null-modem cable).

Boot up your computer with the RIGblaster in the "auto" mode. Watch the "digital" light on the RIGblaster and the PTT transmit indicator on your radio. During the boot up sequence you should see the lights turn on together for several seconds. After boot up they should be off. This test confirms that the cable, the computer, and the RIGblaster are working properly together. All the hardware is working!

If this test is correct continue to the next step.

4. AUTO SERIAL CONTROL SET UP AND TEST: (SKIP THIS STEP FOR VOX OPERATION) Start the program that you have installed and have working. Go to this software's configuration menu (consult the software documentation) and configure the software to use the COM port that you have your serial cable plugged in to. You may also need to set the software to use either DTR or RTS lines; the RIGblaster monitors both.

Set the RIGblaster to the "auto" mode. Put your software in transmit (TX) and check that the "digital" light comes on and that your radio automatically switches to transmit (you should not see any RF output until you complete the next step).

Continue to the next step only if you have this working.

5. CONNECT TRANSMIT AUDIO CABLE: Connect a STEREO audio cable from your sound card line output (laptop headphone output) to the RIGblaster's audio input. You may plug your computer speakers back into the RIGblaster's audio output so that they still operate.

6. SET THE AUDIO LEVEL TO YOUR RIG: Use your normal mic. gain setting with your speech compressor off and the transmitter RF drive all the way up.

Confirm that the RIGblaster's audio level control is turned all the way up (full clockwise as viewed from the back) (DO NOT USE FORCE! You can damage this control).

Open your Windows sound control panel (double click the yellow speaker icon) and unmute or select the wave output and master output. Set the virtual sliders for master and wave to one notch down from the top. Also set the virtual balance sliders to the center.

If your computer speakers are hooked up and they have a volume control knob, turn that knob most of the way, but not all the way, down.

Set the RIGblaster channel selector switch to both channels and the vox/auto switch to auto. Consult the section in this manual on setting transmit audio to get the cleanest signal.

Typical Older Yaesu microphone jumper connections

Pin #	Connection
1	Direct blue shunt jumper
2	Direct blue shunt jumper
3	Direct blue shunt jumper
4	Direct blue shunt jumper
5	Direct blue shunt jumper
6	Push to talk, PTT
7	PTT and Mic. common
8	Microphone audio

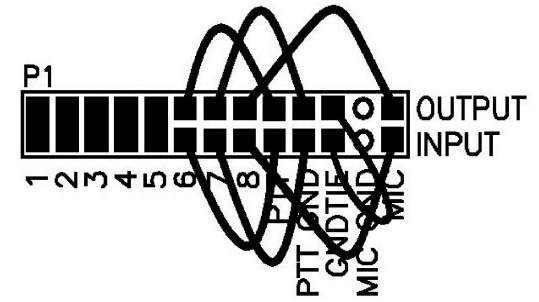

Note: If your radio's manual shows only 1 ground pin on the mic. connector you have this style. Notice the wire jumper on our GNDTIE pins.

**Typical Newer Yaesu jumper connections
Only original mics. for FT1000MP/MK V, FT920, FT990, FT847 etc.**

Pin #	Connection
1	Direct blue shunt jumper
2	Direct blue shunt jumper
3	Direct blue shunt jumper
4	Direct blue shunt jumper
5	PTT common (Ground)
6	Push to talk, PTT
7	Mic. common (Ground)
8	Microphone audio

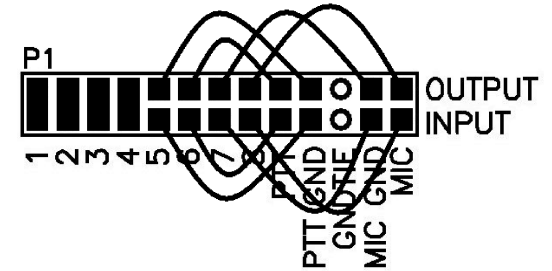

RJ MODEL RIGblaster ONLY or RJ adaptor kit with M8

**Icom Modular RJ45 jumper connections
IC706 (all versions) and Icom FM radios**

Pin #	Connection
1	Direct connection
2	PTT common (Ground)
3	Microphone audio
4	Mic. common (Ground)
5	Push to talk, PTT
6	Direct blue shunt jumper
7	Direct blue shunt jumper
8	Direct blue shunt jumper

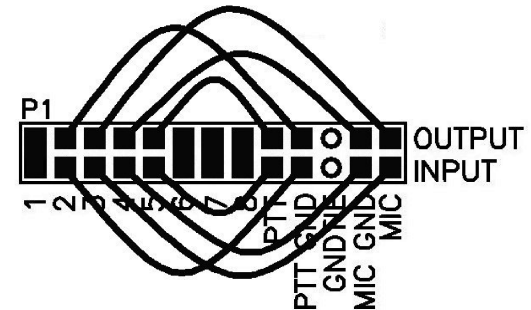

Note: Icom manual diagram has the pin numbers inverted.

MICROPHONE JUMPER CHARTS

M8 MODEL RIGblaster ONLY

Typical Alinco jumper connections

Pin #	Connection
1	Microphone audio
2	Push to talk, PTT
3	Direct blue shunt jumper
4	Direct blue shunt jumper
5	Direct blue shunt jumper
6	Direct blue shunt jumper
7	Mic. common (Ground)
8	PTT common (Ground)

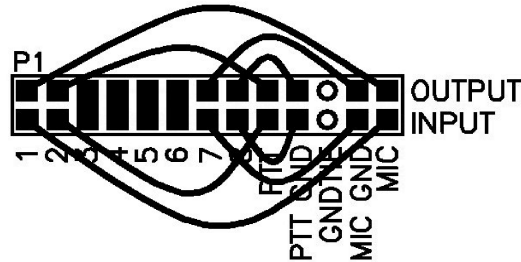

Kachina jumper connections

Pin #	Connection
1	Ground (Mic/PTT)
2	Microphone audio
3	Push to talk, PTT
4	Direct blue shunt jumper
5	Direct blue shunt jumper
6	Direct blue shunt jumper
7	Direct blue shunt jumper
8	Direct blue shunt jumper

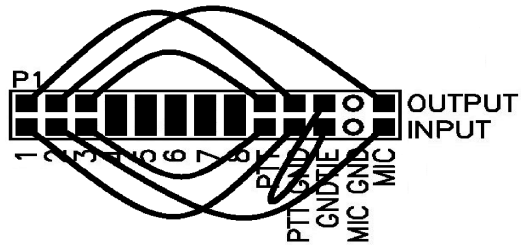

Note: There is a wire jumper on the GNDTIE pins for common mic. and PTT ground.

Kenwood and SGC 2020 jumper connections

Pin #	Connection
1	Microphone audio
2	Push to talk, PTT
3	Direct blue shunt jumper
4	Direct blue shunt jumper
5	Direct blue shunt jumper
6	Direct blue shunt jumper
7	Mic. common (Ground)
8	PTT common (Ground)

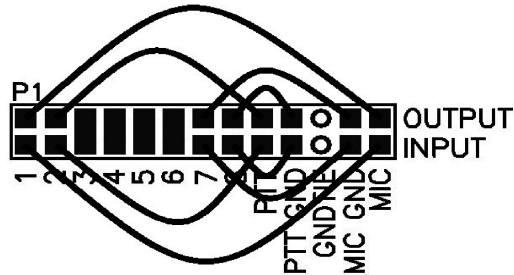

Icom jumper connections

Pin #	Connection
1	Microphone audio
2	Direct blue shunt jumper
3	Direct blue shunt jumper
4	Direct blue shunt jumper
5	Push to talk, PTT
6	PTT common (Ground)
7	Mic. common (Ground)
8	Direct blue shunt jumper

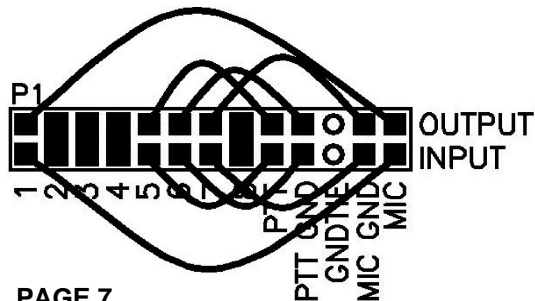

Put your software in transmit. Your RIGblaster digital light should be green and your radio should indicate PTT activation. Audio should be driving your rig and you should be transmitting. The audio level will probably be much too high. Turn down the wave output, master volume and RIGblaster audio level as necessary. You must achieve less than full RF output using your normal mic. setting, with the RF drive set to maximum.

You should be able to achieve a happy balance between controls when all they are all set properly. Remember that the multiple audio controls are cascaded and all interact. If any one of the controls turned down too much it will give the appearance of NO TRANSMIT AUDIO.

If you are using PSK software make sure the transmit audio frequency is between 500 Hz and 2500 Hz. otherwise you will be outside the limits of your radio and you will be unable to transmit properly.

A helpful way to monitor the transmit audio being fed to the RIGblaster is to listen to it at the audio output jack with headphones or computer speakers.

7. WORK LOTS OF DX AND HAVE FUN: You are on the air! Try all the modes, not just one; experiment!

THIS COMPLETES THE BASIC INSTRUCTION SECTION OF THIS MANUAL..... FOR MORE INFORMATION PLEASE READ FURTHER AND VISIT OUR WEB SUPPORT PAGE: <http://www.westmountainradio.com/support.htm>

RIGblaster JUMPER INSTALLATION NOTES:

The jumper diagrams and charts in the back of this manual should be checked against the microphone wiring diagram in your radio's owners manual. Simply make sure that mic. audio, mic. ground, PTT, and ptt ground are on the same pins. It is possible to damage your radio, but only by inadvertently shorting out any DC voltage that may be on the mic. jack. Pay particular attention to this before turning on your radio.

The diagrams only depict the actual appearance of the jumper block in the RIGblaster. The black rectangles depict where the blue two-pin jumpers go. The black squares with the wires depict where the black and white wire jumpers go. The circles denote no jumpers or connections.

Remember that if your stock microphone checks out perfectly, including on the air reports, you have the jumpers installed correctly and you are done with the jumpers.

After completing the jumper installation you may put the cover on. Carefully align the rear panel over the connectors and the control making sure that the side screw holes line up. Be careful not to put pressure on the switch levers with your thumbs when putting the cover on. The screws are sheet metal type and must be driven in firmly with a fresh properly fitting #2 phillips head tip. They will be tight at first and then will go easier, do not overtighten them when they reach bottom.

SETTING THE AUDIO LEVEL TO YOUR RIG:

Before using the RIGblaster you must have your radio set up properly for normal SSB operation. Changing your microphone gain or speech processor settings on your rig after setting up the RIGblaster will require that you re-adjust the RIGblaster or computer.

To have the best possible signal, you need to understand how your rig is adjusted. Modern rigs may have several adjustments for transmit audio, including; mic. gain, mic. equalization and/or transmit shift, speech compression and ALC (automatic level control). The objective of setting these adjustments is to have clean clear audio and a minimum amount of splatter or RF bandwidth.

The primary adjustment is your mic. gain. This sets amount of the audio amplification for the microphone. The speech compressor basically makes loud speech softer and soft speech louder, reducing the range between soft and loud. If your rig has transmit shift or equalization of the audio you can also adjust the tone quality of your audio. An ALC circuit is provided to minimize the possibility of too much audio over driving the rig and causing flattopping or splatter. You should understand the interaction of these circuits, and their adjustments. Consider your microphone and personal voice characteristics. To get the best audio from your station and work the most DX you need to set your radio carefully. Turning everything up for maximum smoke will NOT make you more intelligible....you will just be distorted.

The basic idea of adjusting your rig is to not overdrive it, and to achieve best intelligibility. Do not simply use your power output meter, but in addition use the ALC and speech compression metering too.

Turn off your speech compressor and watch the ALC meter. Set the mic. gain BELOW the correct maximum ALC indication on your loud speech. Your particular speech characteristics and operating habits must be considered.

Adjust your transmit shift and/or transmit audio equalization (tone control) for the best on the air reports. You should consider the tone characteristics of your voice, your mic. and your rig's audio. Once you have set your tone equalization you may have to re-adjust the mic. gain.

If you use speech compression do not over do it. You should use a moderate amount. Remember that you will sound more natural without it and your shack noises will not be picked up as much. Re-check your ALC indication with the compressor on. You should ALWAYS be under the maximum correct ALC indication. With compression you should indicate more ALC activity but not necessarily higher.

Now that you have the rig set up properly for voice you can set the audio drive level from your computer to your rig. Do not the change these settings.

Turn off your speech compressor. Set the Windows volume control (double click the speaker icon in your system tray) and the wave volume as high as needed to drive your rig properly. This setting may also may be regulated with the RIGblaster's "audio level"

The channel selector switch allows you to choose left, right, or both channels of your sound card. You will usually get twice as much audio with the switch in the "both" position because the channels are mixed together. You may use this switch to select the appropriate channel when using software that processes receive signals on one channel while transmitting on the other. The normal setting is "both".

The vox/auto switch selects the mode of PTT control and the audio switching. In the auto mode the mic. is always connected normally and the computer audio is selected automatically when the RIGblaster receives a PTT control command from the computer's serial port. If the computer is transmitting you may override it by pushing the PTT switch on your mic. and talking. In the VOX mode the computer audio is connected to work your rig's VOX circuit. In the RIGblasters VOX mode you cannot use VOX, MOX or footswitch to activate your mic., only the mic. PTT button.

The "digital" LED shows green whenever the computers' audio is routed to your radio's mic. jack. It turns green in the auto mode with serial control activation, or it is always on when in the VOX position. Whenever you push the mic. PTT button it will go out indicating that your mic is connected.

The power LED shows that 12 Vdc is applied. The RIGblaster has no on/off switch as the power consumption is less than 0.2 watts in the auto position. It will run for about 60 years for the price of a power switch. The RIGblaster has extensive power surge protection and it is not necessary to turn it off.

We included your choice of 3M Bumpon protective feet or double sided adhesive pads. You may want to stick the RIGblaster down, up or sideways with the pads.

TROUBLESHOOTING

If you installed the RIGblaster following the steps in this manual you need not go back to a previous step. The problem is isolated to the step that you found the problem on. Most problems are software related and you need to consult your softwares' documentation.

If you would like further help, see our support page, for the latest help and suggestions: <http://www.westmountainradio.com/support.htm>

Please understand that the RIGblaster will not work if the software and computer does not work. Make sure that you have your software operating properly before connecting the RIGblaster and expecting it to work. You must read the documentation that comes with the software! Software instructions are not included in this manual. We did not write the software and we cannot support the software. The best thing to do if you have software problems it to try an different software package. If you have problems with two or more sound card programs you probably have a problem with you Windows sound card software installation not your hardware.

Enjoy operating and work lots of DX!
Dan Gravereaux, N1ZZ and Del Schier, K1UHF

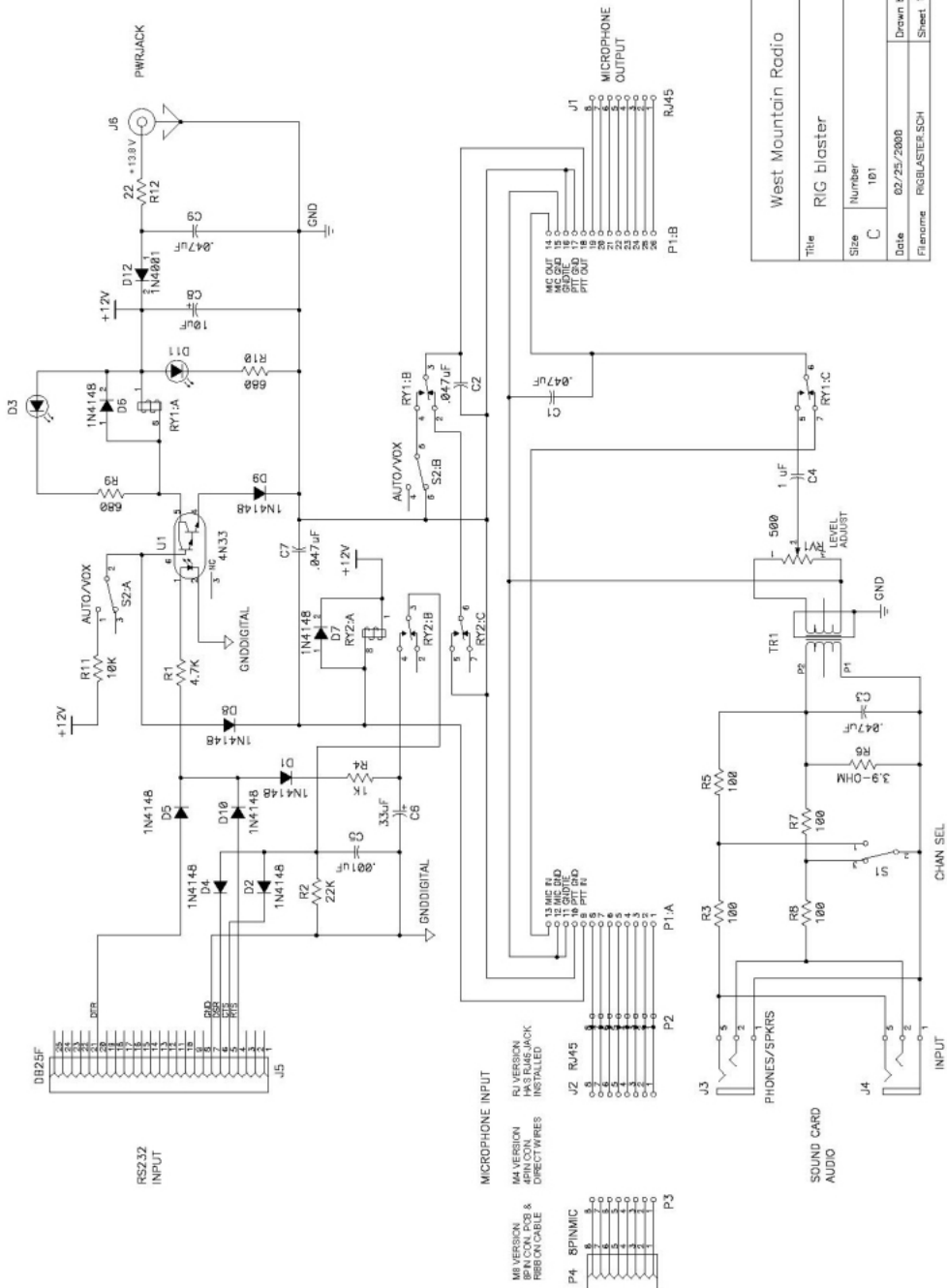

West Mountain Radio			
Title	RIG blaster		
Size	Number	Rev	
C	101	B	
Date	02/25/2000		Drawn by K1UHF
Filename	RIGBLASTER.SCH		
			Sheet 1 of 1

control. Set all of these RF controls so none of them are near all of the way up or down. Remember that all of the adjustments are all cascaded (in series), and they all interact.

Transmit. Set your RF drive to maximum while adjusting the multiple audio level adjustments for about 50% power. You should not exceed the AM, FM or RTTY power ratings of your radio. After setting make sure you ALC meter is below maximum.

Note that if you run your sound card at maximum and the RIGblaster level turned way down you will have distortion from your sound card and a poor quality signal.

VOX OPERATION

To set up for vox operation, instead of automatic serial control, you need to understand the switching within the RIGblaster. In the auto mode your mic. is connected by default and it will work normally with your radio's VOX. In the RIGblaster's VOX mode your mic. is disconnected and your computer audio is hooked up. Therefore, your computer audio may activate your rig's VOX circuit.

To set the VOX level controls you need to set all the levels as described previously. Turn your rig's VOX on. Set the level, delay and anti-trip controls so that it works well with your mic. The same settings should work with the computer since the computer audio should be matched, almost exactly, to the same level as your voice from your mic.

SWITCHES, CONNECTIONS, INDICATORS AND FEET

The back panel: You will find a yellow DC power connector for the supplied AC adapter. The RIGblaster needs approximately 12 Vdc. The center pin is positive. You may run it directly from 10 to 16 Vdc but you need to keep the grounding physically close to the radio's mic circuit ground. This will avoid ground currents that may spoil your transmit audio.

The DB25 serial connector is for two way PTT control from a standard modem cable connected to a serial port.

The audio level adjustment potentiometer gives a great range of adjustment to match the nominal output of the computer to your radio's mic. jack. Clockwise facing the back is maximum audio level.

The audio input and outputs accept standard 1/8" stereo mini plugs. These jacks are wired in parallel and the output may be used to monitor the audio from the computer that is fed to the RIGblaster's input jack.

The Modular RJ45 jack accepts the supplied RIGblaster mic. cable that feeds the mic. jack on your radio.

The Front panel: The mic. jack varies according to the RIGblaster model; the M8 has a standard 8-pin screw on jack, the M4 has a standard 4-pin screw on jack and the RJ has a modular RJ45 8-wire jack. This is where you connect your mic.

Typical station hookup diagram.

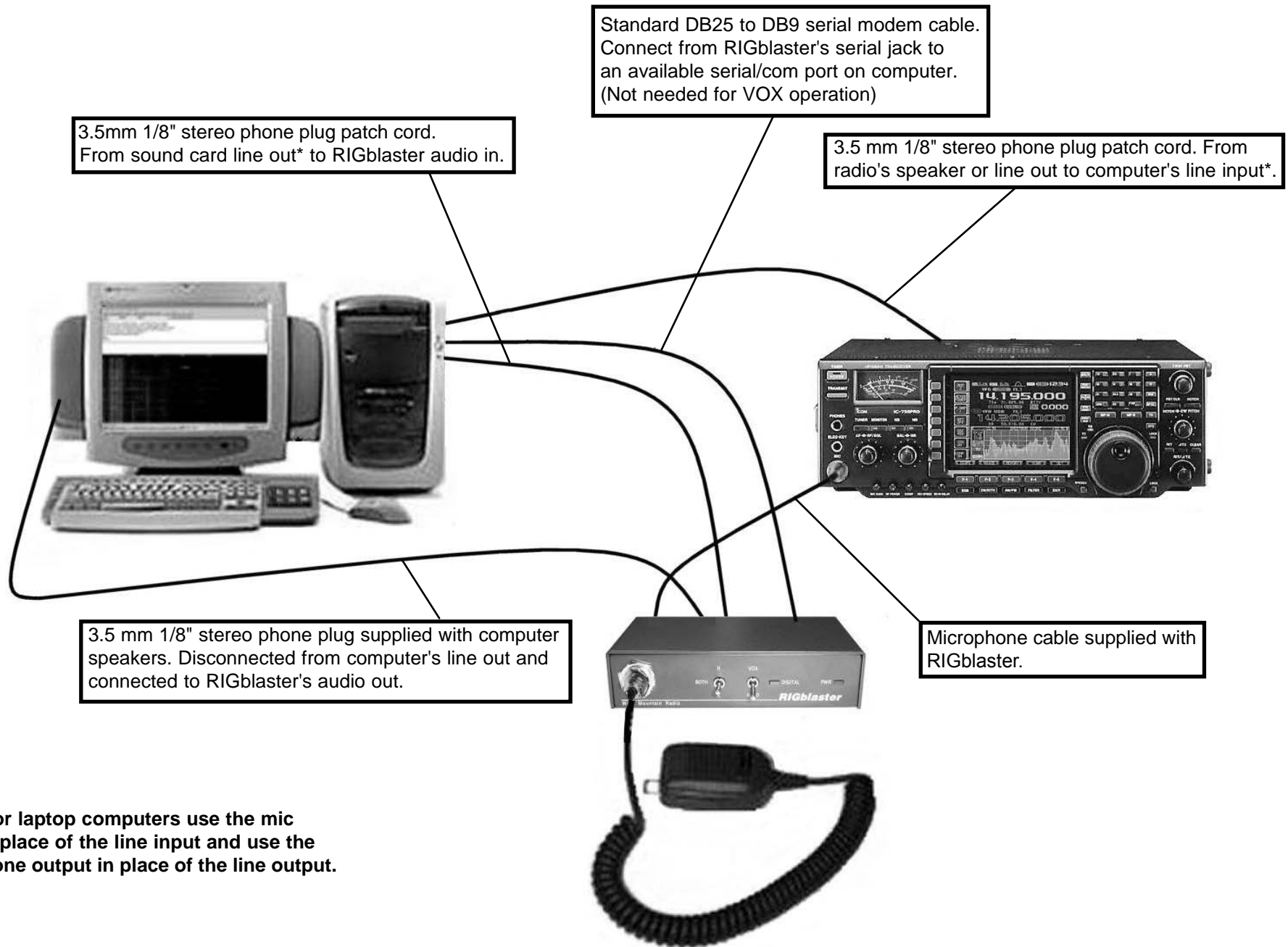

RIGblaster Warranty

The Compact Disc of Radio Amateur Software Collection is excluded from any and all warranties by West Mountain Radio. Note that the programs have been provided as shareware or freeware by the software authors to the amateur radio community for their use and enjoyment. The CD is to be used at your own risk.

The RIGblaster is warranted against failure due to defects in workmanship or materials for one year after the date of purchase from West Mountain Radio. Warranty does not cover damage caused by abuse, accident, misuse, improper or abnormal usage, failure to follow instructions, improper installation, alteration, lightning, or other incidence of excessive voltage or current. If failure occurs within this period, return the RIGblaster or accessory to West Mountain Radio at your shipping expense. The device or accessory will be repaired or replaced, at our option, without charge, and returned to you at our shipping expense. Repaired or replaced items are warranted for the remainder of the original warranty period. You will be charged for repair or replacement of the RIGblaster or accessory made after the expiration of the warranty period.

West Mountain Radio shall have no liability or responsibility to customer or any other person or entity with respect to any liability, loss, or damage caused directly or indirectly by use or performance of the products or arising out of any breach of this warranty, including, but not limited to, any damages resulting from inconvenience, loss of time, data, property, revenue, or profit, or any indirect, special incidental, or consequential damages, even if West Mountain Radio has been advised of such damages.

Except as provided herein, West Mountain Radio makes no express warranties and any implied warranties, including fitness for a particular purpose, are limited in duration to the stated duration provided herein.